

OPERATING MANUAL

LM^{Pro}

LM^{Pro} H

User Programmable Temperature and Humidity Data Logger

Model No.: 411040



Manufacturers of :

- Circular Chart Recorders
- Inkless Recorders
- Paperless Recorders
- Scanners & Data Loggers
- Networked Data Loggers
- Application Software
- WHO PQS Qualified Data Loggers
- Vaccine Series Data Loggers

G-TEK CORPORATION PVT. LTD.

"Gunaji House"
Plot No. 25/1, Besides Status Bungalow,
Padra Road, Vadodara – 391410.
tel.: +91-98245 24140
e-mail: info@gtek-india.com
url: www.gtek-india.com

CONTENTS

List of Tables	2
List of Figures	2
1 SAFETY AND THE ENVIRONMENT	3
1.1. About this document	3
1.2. Ensure Safety.....	3
1.3. Protecting the Environment	3
2 SPECIFICATIONS.....	4
2.1. Use.....	4
2.2 Technical Data	4
3 UNPACKING THE PRODUCT.....	7
3.1 Unpacking and Inspection of LM ^{Pro} H Data Logger	7
3.2 Mechanical Dimensions of LM ^{Pro} H Data Logger	8
4 PRODUCT DESCRIPTION.....	9
4.1 Status LEDs	9
4.2 Display (LCD)	9
4.3 Functions of Key	10
5 USING THE PRODUCT	11
5.1 Configuring the Device	11
5.1.1 Alarm Configuration	11
5.1.2 Batch Configuration	12
5.2 Configure Multiple Devices	13
5.3 Batch Start of the Device.....	14
5.4 View Min/Max and Current Temperature Data.....	14
5.5 View Min/Max and Current Humidity Data.....	15
5.5 Inserting a Tag Event.....	15
5.6 Displaying of Reading in Normal and Alarm Condition	15
5.7 Measurement of the data	17
5.7.1 Start Recording data	17
5.7.2 Tag Events	17
5.7.3 Ending the Measurement	18
5.8 Reading out Data	18
5.8.1 Connecting with the Software Application	18
5.8.2 Download the Measurement Readings.....	19
5.8.3 Generating PDF Report	21

6 MAINTAINING THE PRODUCT	23
6.1 Accessories.....	23
6.2 Cleaning the Data Logger	23
6.3 Changing the Battery	23
6.4 Battery Disposal	24
7 TIPS AND ASSISTANCE	25

List of Tables

Table 1 Technical Specifications	4
Table 2 Status LEDs indication	9
Table 3 Frequent Asked Questions (FAQs)	25

List of Figures

Figure 1 LM ^{Pro} H Data Logger.....	7
Figure 2 Overall Dimensions of LM ^{Pro} H Data Logger	8
Figure 3 LCD Display format.....	9
Figure 4 Set up Alarm.....	11
Figure 5 Set up Batch	12
Figure 6 Set up Batch on Multiple devices.....	14
Figure 7 Start Batch Manually.....	14
Figure 8 View Min/Max Temperature and current reading	14
Figure 9 View Min/Max Humidity and current reading.....	15
Figure 10 Insert Manual Tag	15
Figure 11 Manual Stop of Running Batch	18
Figure 12 USB Type- A connection.....	19
Figure 13 Current Temperature & Humidity reading of the LM ^{Pro} H Data Logger.....	19
Figure 14 Selecting file location for saving data summary	20
Figure 15 Downloaded data summary.....	20
Figure 16 Option for downloading multiple device data in existing file.....	21
Figure 17 Multiple device data in One file.....	21
Figure 18 Filling up the options to generate PDF report	22
Figure 19 Selecting file location for saving PDF report.....	22
Figure 20 Battery replacement steps.....	24

1 SAFETY AND THE ENVIRONMENT

1.1. About this document

This instruction manual is an essential component of the product.



Please read this documentation carefully and pay attention to the safety instructions and warning notices to prevent injuries and damage to the product.

Keep this document handy so that you can refer to it when necessary.

1.2. Ensure Safety

- Operate the product properly, for its intended purpose and within the parameter specified in the technical data. Using it beyond the specified limit can cause damage to the product and personnel also.
- Do not use the product if there are signs of damage to the housing.
- There are no user serviceable parts inside. For any defect, please consult the factory or the dealer from where you bought.

1.3. Protecting the Environment

- All the materials used in the data logger are RoHS and Reach compliant. There are no hazardous parts in the data logger.
- The Data logger has marking for RoHS  and CE  compliant.
- Disposal properly  marking on the LM^{Pro} H data logger indicates that data logger and its accessories should not be disposed of with other household or commercial waste at the end of their working life.
- Dispose of faulty rechargeable batteries/spent batteries in accordance with the local regulations or valid legal specifications.

At the end of its useful life, send the product to a separate collection for electric and electronics devices (observe local regulations) or return the product to G-Tek for disposal. (Dispose or recycle the LM^{Pro} H programmable data logger in accordance with the WEEE 2012/19/EU guidelines or your local regulations. For suitable recycling, the device may also be returned to the manufacturer.)

2 SPECIFICATIONS

2.1. Use

LM^{Pro} H User Programmable Temperature and Humidity Data logger is an Internal sensor data logger meeting the requirements of **WHO PQS E006/TR05.1**. It stores up to 50000 data. User can fully configure parameters like – Start delay, alarm high/low with corresponding alarm delay, alarm event type- single/cumulative, temperature unit, store interval etc. User can also set the information like, username and job description. Software automatically sets the UTC time zone at the time of configuration of device. User can download multiple data loggers in single file. User can generate report in pdf format or export data as a csv file. Data loggers come with individual NABL traceable calibration certificate.

The temperature and humidity readings are monitored and saved throughout the entire duration of measurement program.

LMViewE051 software needs to be installed in PC To download data to generate a report in pdf format and to export data in csv format for further use.

2.2 Technical Data

Table 1 Technical Specifications

Model	LM ^{Pro} H
General	
Integrated Sensor	Solid state MEMS Sensor [#]
Temperature Measurement Range	-20 °C to + 60 °C (-4 °F to +140 °F)
Accuracy	± 0.5 °C for the range +10 °C to + 40 °C ± 0.7 °C otherwise
Resolution	0.01 °C - Display and storage 0.01 %RH – Display and storage
Humidity Measurement Range	0 to 100 %RH
Accuracy Humidity	± 3 %RH for the range 20 to 80 %RH ± 5 %RH otherwise
Unit of Measurement	Temperature in °C (User has an option to view in °F) Humidity in %RH
Calibration	Each device accompanies NABL (ISO/IEC 17025) traceable certificate
Alarm	Visual
Alarm Settings	Fully user programmable four alarms for temperature and humidity with alarm type(High/Low), event type(single/cumulative) , alarm delay(Hr:Mn) selection for temperature and humidity.
Logging Interval	Logging interval is user programmable from 5 seconds to 18 hours
Delayed Start Option	Yes. User can program start delay from 0 seconds to required no. of days by selecting date and time.

Power Requirement	
Battery	User Replaceable 3.0 V 225 mAh; CR2032 Panasonic (or Equivalent) Coin Cell Battery;
Battery Life	Up to 1 year battery operating life with shelf life of 1 year (if data is stored at 15 min interval and display OFF mode). The battery indicator on the display provides information on the remaining lifetime.
Environmental Specification	
Temperature during Transportation and Storage – Device inactivated	-20 °C to + 55 °C
Temperature during operation [#]	-20 °C to 60 °C (EN 12830:1999 Table3, Climatic Type C)
Humidity During Transportation, Storage and usage	0 to 95% RH non-condensing
PC Interface and Software	
PC Interface	Data of more than 1 year (for 15 min logging interval) can be extracted using LMViewE051 software.
Software Compatibility	LMViewE051 is compatible with Windows Operating System currently supported by Microsoft.
Connectivity	USB 2.0 Type-A Ports Compatible; Data Download Time: approx. 8 minutes for full data download.
Human Interface	
Display Type	Character LCD Display with Min, Max, Battery Level Indication, OK/Alarm, Alarm High/Low with event type – single/cumulative, Bell symbol, REC indication and Current reading with measurement unit.
Memory Size	50000 data storage
Batch Type	Stop on Full: The batch stops when the maximum number of readings is reached.
	Rollover: When the maximum number of readings is reached, data is overwritten cyclically on a first-in-first-out basis.
Activation	Device activation is by software at preset start delay time. If user requires instant activation of the device before preset start delay manually, it can be activated by long press of “ Start ” key for more than 10 seconds.
De-Activation	De-activation is automatically occurred when preset stop time or maximum number of readings has reached (Batch Type- Stop on Full). De-activation is possible manually by keyboard/ giving STOP command from software.
Status Indicator	RUN: Recording; Red LED flashes while device is storing. STP: Standby; Red LED flashes while device is not storing.
Alarm Visual	Flashing temperature reading on display along with ▲ or ▼ arrow for high or low alarm with bell symbol.
Power ON Indication	RUN LED blinks in active mode; LCD shows temperature data along with “ REC ” and alarm indications if any.
Mounting Device	Through hole provided. Refer to operating manual for dimensions details
Material	Polycarbonate Plastic: non-breakable, non-corrodible housing

Warranty	12 months from the date of dispatch. Refer to warranty certificate for more details.
Service Provision	No user serviceable parts inside, except battery replacement
Physical Characteristics	
Overall Dimension (L x W x H) mm	95.5 x 45 x 14.8 mm
Weight	Approx. 51 grams
Standards	
Electromagnetic Compatibility	IEC 61000-6-2/6-3
Resistance to Electrical Storms	IEC 61000-6-2; (IEC 61000-4-2 Basic Standard for applicability of tests)
IP Rating	IEC 60529: IP 30
Impact Resistance	5 drops from 1 meter onto concrete floor at room temperature with battery in place. Device does not get damaged and there is no loss of calibration.
Vibration	EN12830:1999 Clause 4.9.3.2 and Test Method 5.6.6
RoHS	Compliant (EU directive 2011/65/EU)
Verification	In accordance with PQS verification protocol E006/TR05.VP.1

*: Available as per order code selected. Specifications are subject to change without notice.

The sensor has the highest accuracy between + 5 °C to + 60 °C and 20 to 80 %RH. If the device is exposed to high humidity for a prolonged period, the measuring accuracy decreases. Prolonged exposure may introduce shift in the sensor reading with a slow recovery time. The data logger must not be exposed to a relative humidity of 100% for longer time.

3 UNPACKING THE PRODUCT

3.1 Unpacking and Inspection of LM^{Pro} H Data Logger

- LM^{Pro} H data logger is dispatched in a recyclable, environment friendly package specially designed to give adequate protection during transit.
- If the outer box shows sign of damage, it should be opened immediately, and the device be examined. If the device is found damaged, it should not be operated, and the local representative contacted for instructions.
- Ensure that all accessories and documentation are removed from the box.
- If the LM^{Pro} H data logger is for immediate use, you can start installing it as per Installation instructions.
- **Please preserve the original packaging along with all internal packing for future transport requirements.**

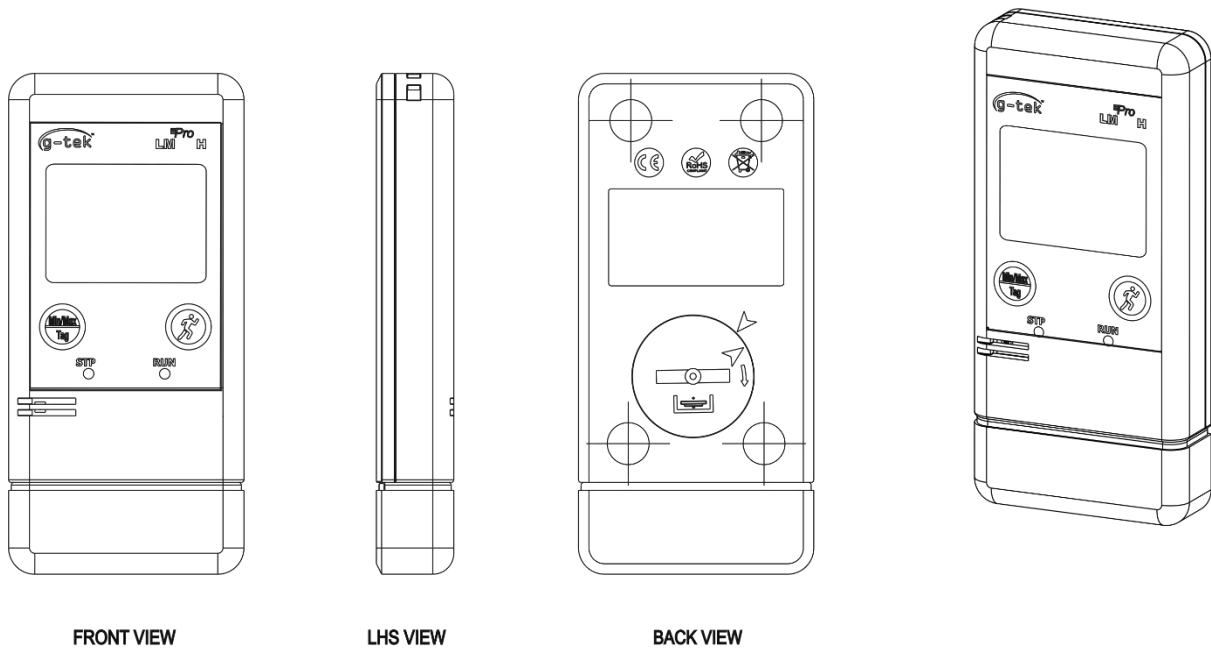

Figure 1 LM^{Pro} H Data Logger

3.2 Mechanical Dimensions of LM^{Pro} H Data Logger

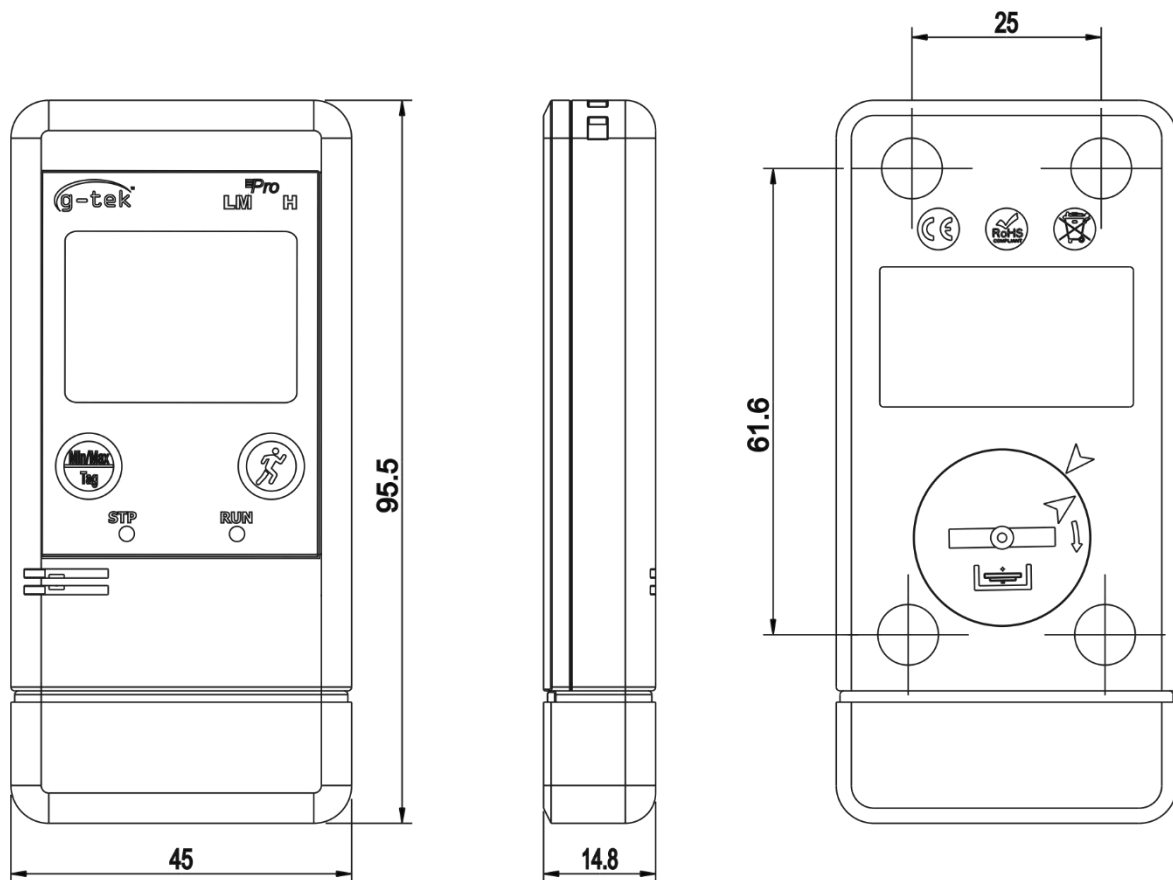

Figure 2 Overall Dimensions of LM^{Pro} H Data Logger

Overall Dimensions	
Dimension (L x W x H) mm	95.5 x 45 x 14.8 mm approx.
Mounting	Through hole provided
Weight	Approx. 51 grams

4 PRODUCT DESCRIPTION

4.1 Status LEDs

Table 2 Status LEDs indication

Indicator	Description
RUN	Data Recording has started. At this time, the STP LED will be off and RUN LED will blink.
STP	Data Recording is Off, and device is On. At this time, RUN LED will be off and STP LED will blink.

4.2 Display (LCD)

The multi-Character LCD Display consists of Min/Max, Battery Level Indication, OK/Alarm, Alarm High/Low with event type – single/cumulative, Bell symbol, REC indication and Current reading with measurement unit. The position and description of each segment is shown in figure 4.

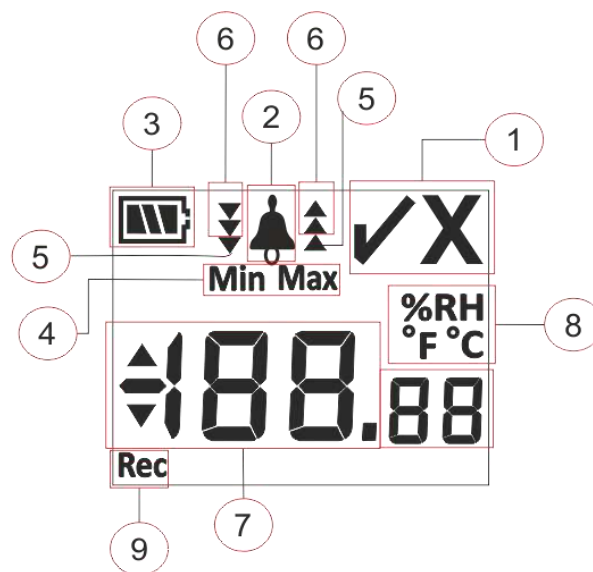





Figure 3 LCD Display format

- 1) OK ✓ / NOK X symbol:
 - a. If any time during batch running condition, alarm limits are crossed, the symbol “X”, **NOK will be turned on and will remain even if the alarm is restored.**
 - b. If any time during batch running condition, alarm limits are not crossed, the symbol “✓” remains on the display.
- 2) Bell symbol for alarm indication
- 3) Battery capacity: Sufficient  ; Partly empty  ; Low  ; Empty 
- 4) Min: Minimum stored reading for the given day
Max: Maximum stored reading for the given day

- 5) High ▲ / Low ▼ alarm indication if reading exceeded single alarm limit.
- 6) High ▲▲ /Low ▼▼ alarm indication if reading exceeded cumulative alarm limit.
(In case of both single and cumulative alarm limit is exceeded, all 3 arrows will be displayed for high ▲▲▲ /low ▼▼▼ alarm condition)
- 7) Current temperature or Humidity reading
- 8) Temperature and Humidity Measurement unit (°C / °F / %RH)
- 9) REC: Indicates the device is in recording mode.

Note: For Technical reasons, the display intensity of liquid crystal display becomes lower at temperatures below 0°C. This has no influence on the measuring accuracy. For technical Reasons, the battery performance decreases at lower temperatures. The device should not be subjected to temperature beyond the recommended range. In case the device is exposed to temperatures outside the specified range, the device may behave erratically and get reset.

4.3 Functions of Key



Min/Max key: It is used to view current Temperature Min/Max reading. It is also used to enter manual Tag and to stop the batch.



Start key: It is used to start recording of the device instantly after configuration (if required). It is also used to view current Humidity Min/Max reading.

5 USING THE PRODUCT

5.1 Configuring the Device

The configuration process of the device has two parts: Alarm Configuration and Batch Configuration.

5.1.1 Alarm Configuration

Connect the LM^{Pro} H data logger to the PC via USB Type-A port. Open the LMViewE051 Software application and configure the alarm parameters as shown in figure 4. For detailed process of application refer software help file.

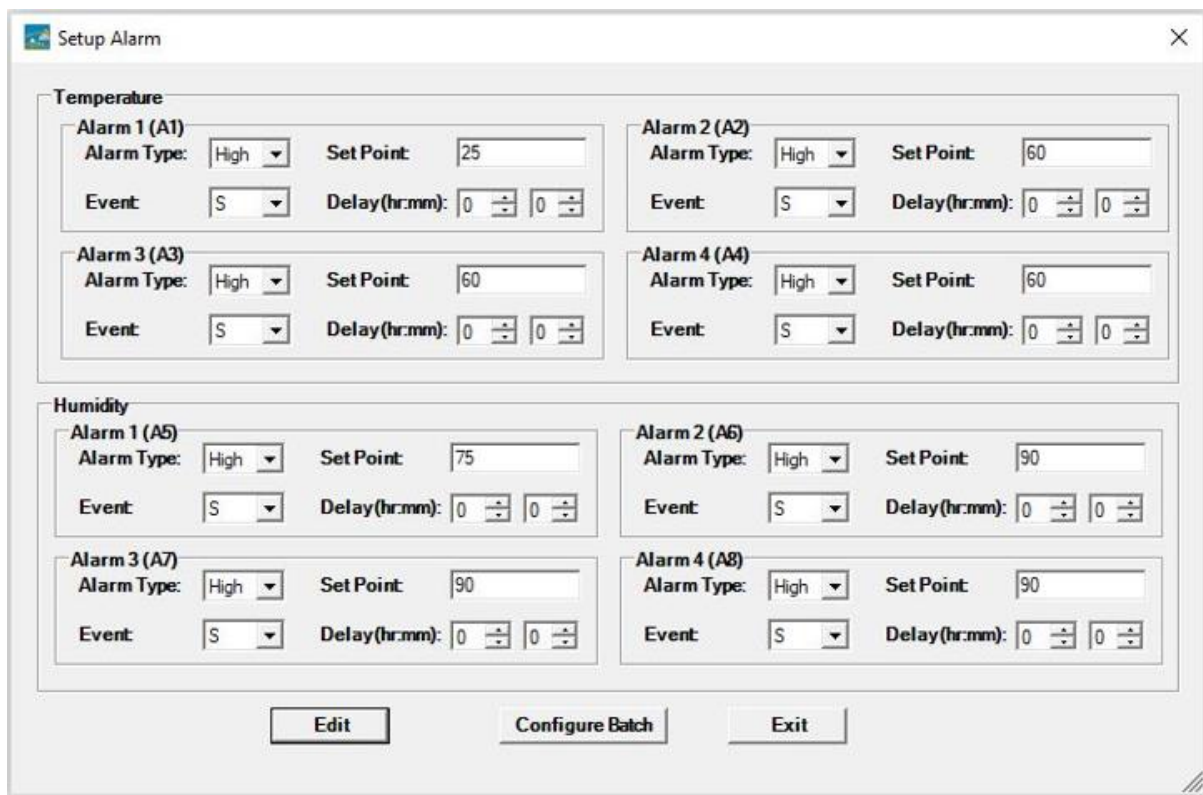

Figure 4 Set up Alarm

In Alarm Configuration, there are four alarm conditions available for each temperature and Humidity setting. The default alarm settings (last set alarm settings) will be seen as shown in figure 4.

The parameters of temperature and humidity alarm configuration are as follows:

Temperature and humidity:

1. **Temperature Alarm No.:** Alarm -1 (A1) to Alarm-4 (A4).
2. **Humidity Alarm No.:** Alarm -1 (A5) to Alarm-4 (A8).
3. **Alarm Type:** Set the alarm type High/Low as required.

4. **Set point:** Enter the appropriate Temperature and Humidity value in °C and %RH respectively as per required alarm condition.
5. **Event:** Set the alarm type **Single / Cumulative** as required.
 - a. **Single Event:** Single event alarm occurs when a reading remains beyond temperature and/or humidity alarm set point continuously for more than the set period of time.
 - b. **Cumulative Event:** when the total time of reading exceeding the cumulative alarm set point of temperature and/or humidity is more than set delay, it is considered as a cumulative event.
6. **Delay:** Set the required alarm time delay in hr:mn for alarm trigger. The range for alarm time delay is from 00:00 to 23:59 (hr:mn). Alarm time delay for cumulative event should be more than or equal to that of single event.

Note: It is advisable to set all eight alarm parameters, else the default parameters for the remaining alarms will be applied.

5.1.2 Batch Configuration

After configuring the alarm parameters select the “**Configure Batch**” button to configure the batch for the device as shown in figure 5.

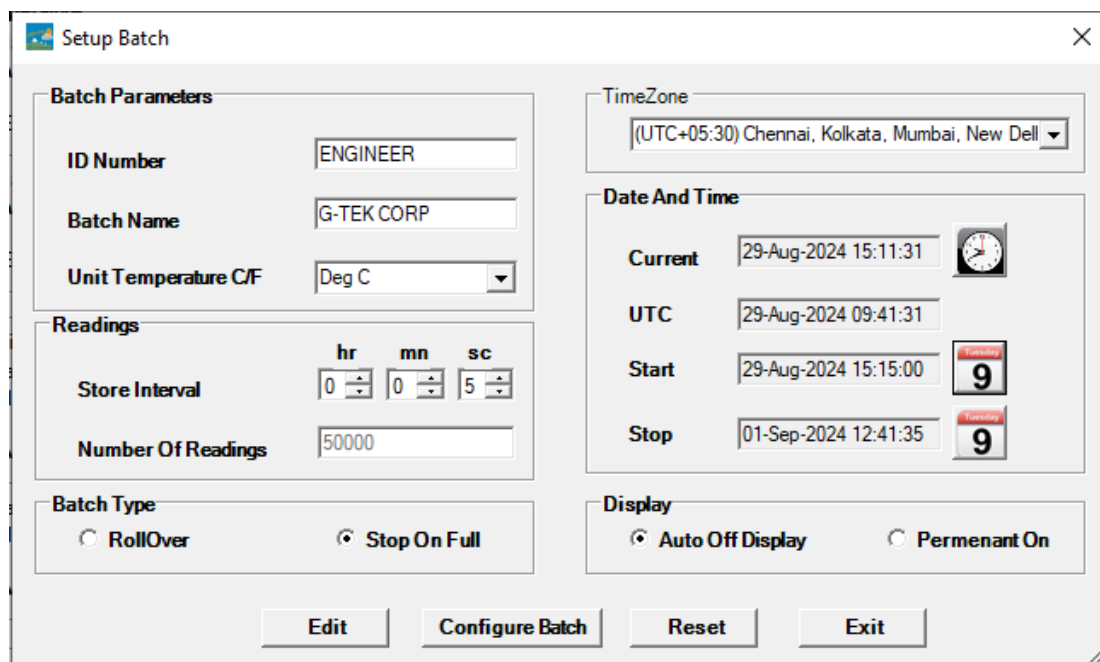

Figure 5 Set up Batch

In Batch configuration of the data logger following terms are configured:

1. **ID Name:** User can assign an appropriate ID Name of Maximum 10 alphanumeric characters. ID name signifies the identification of device or location name for the data logger.
2. **Batch Name:** User should give an appropriate batch name of Maximum 10 alphanumeric characters.
3. **Unit of measurement:** The unit for temperature is °C and for Humidity is %RH.

4. **Store Interval:** It is the interval between two successive logging of data. It can be set from 5 seconds(minimum) to 18 hours(maximum).
5. **No. of Readings:** This shows no. of data that will be stored for the given batch configuration. This number is calculated based on Batch start, stop time and store interval. The maximum no. of readings is 50000.
6. **Batch Type:**
 - a) **Rollover:** When the maximum no. of readings is reached, data is overwritten cyclically on a first-in-first-out basis.
 - b) **Stop On Full (default):** The batch stops when the maximum no. of readings is reached.
7. **Time Zone:** Select the appropriate time zone from the drop down. The time zone will be as per UTC time.
8. **Current Date and Time:** It shows the current date and time of the LM^{Pro} H data logger. Click on the “**clock**” button to sync the current date and time of the device with PC time as per selected time zone.
9. **Start Time:** It is the time at which Batch will start in the device. User can preset the batch start time by selecting the date and time as per required batch start delay. The first data is stored at the batch start time.
10. **Stop Time:** It is the time at which the batch will be stopped in the device. User can set the stop time, if required otherwise it will be calculated based on the start time and store interval as per maximum number of readings. This field will be disabled with prefixed date and time, when the batch type is selected as Rollover.
11. **Display Options:**
 - a) **Display Auto Off (default):** This option is normally selected to save battery life of the data logger.
 - b) **Display Permanent On:** This option will reduce the battery life of the data logger.

After setting the batch parameters, press “**Configure Batch**” button to configure the batch for the device.

5.2 Configure Multiple Devices

If multiple devices are to be configured with the same parameters, user should select the multiple batch configuration option in the software application.

- Follow the steps as per section 5.1.1 and 5.1.2 for the alarm and batch configuration for the first device.
- Select the suitable start time of the batch so that multiple devices can be configured and started at the same start time.
- After configuring the first device, the message window will pop up as shown in figure 6. Connect another device to the PC application, click on “**OK**” button to proceed further.
- The user can update the ID and Batch name for the other devices, remaining parameters in the batch configuration remain same.

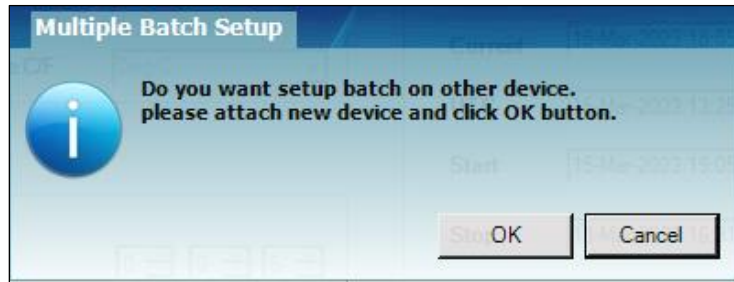

Figure 6 Set up Batch on Multiple devices

- Once the configuring multiple devices is finished, click on “**Cancel**” button and exit from the configuration setup.

5.3 Batch Start of the Device

Once the batch configuration is completed from LMViewE051 application, recording of data will be started by one of the following criteria:

1. Once the configured start time has been reached.
2. User can manually start the device after batch configuration, if required by pressing “**Start**” key for about 10 seconds as shown in figure 7.

When the recording of data is started, **STP** LED turns off and **RUN** LED starts flashing and “**REC**” message is seen on display.

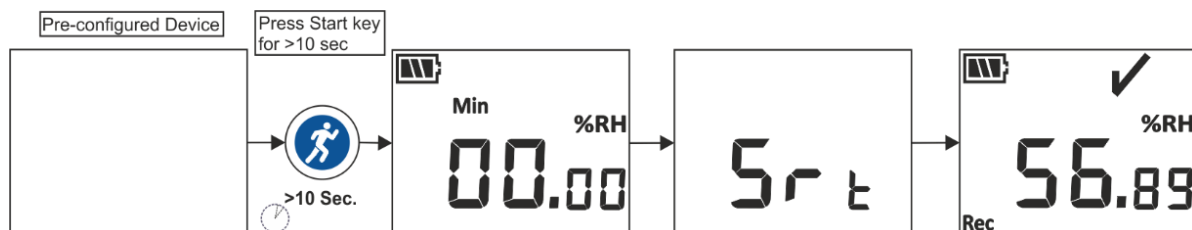

Figure 7 Start Batch Manually

5.4 View Min/Max and Current Temperature Data

As described in key functions ([section 4.3](#)), by pressing “**Min/Max**” key for 1 sec in normal running condition, the display will show Min/Max temperature data for the device and current data reading respectively as shown in figure 8.

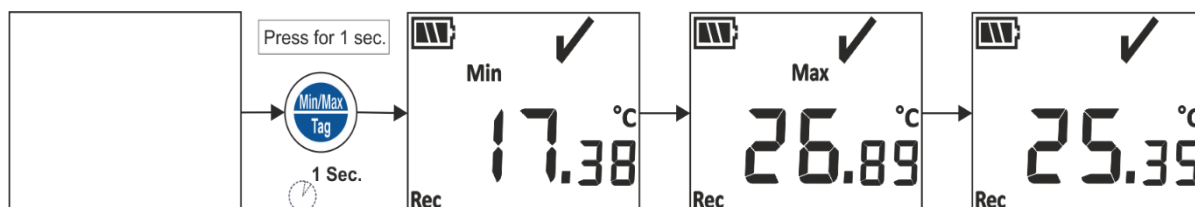

Figure 8 View Min/Max Temperature and current reading

5.5 View Min/Max and Current Humidity Data

As described in key functions ([section 4.3](#)), by pressing “Start” key for 1 sec in normal running condition, the display will show Min/Max Humidity data and current data reading respectively as shown in figure 9.

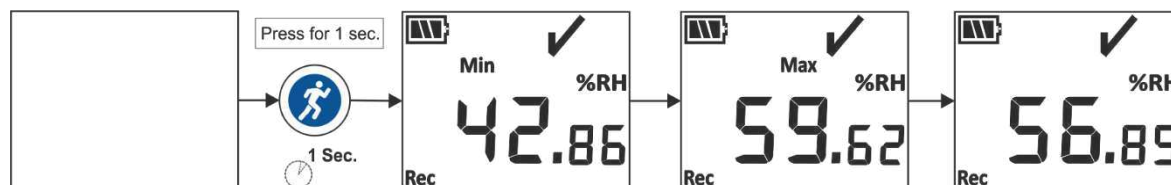

Figure 9 View Min/Max Humidity and current reading

5.5 Inserting a Tag Event

Whenever user wants to record a specific data other than at the logging interval, it can be done by Manual Tag feature of the device.

While recording of data is going on, user can enter special event with time stamp by pressing “Min/Max” key for more than 4 seconds. “Tag” message is seen on device display as shown in figure 10.

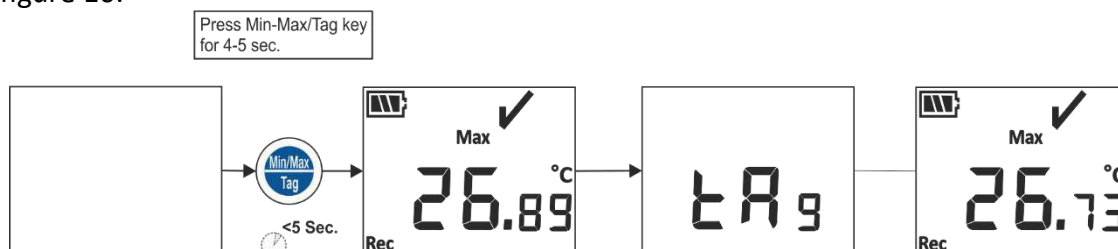

Figure 10 Insert Manual Tag

5.6 Displaying of Reading in Normal and Alarm Condition

Consider the table below as alarm configuration of data logger to understand the LCD Images, alarm A1 to A4 are for temperature and alarm A5 to A8 and for Humidity:

Temperature Alarm Configuration				
Alarm No.	Alarm Type	Set point (°C)	Event Type	Delay (Hr:Mn)
A1	High	40	Single	01:00
A2	High	27	Cumulative	10:00
A3	Low	15	Cumulative	05:00
A4	Low	10	Single	00:30
Humidity Alarm Configuration				
Alarm No.	Alarm Type	Set point (%RH)	Event Type	Delay (Hr:Mn)
A5	High	85	Single	01:00
A6	High	70	Cumulative	10:00
A7	Low	35	Cumulative	05:00
A8	Low	30	Single	00:30

- 1) Reading is within all high/ low alarm set points.
 - OK sign, battery, reading and unit will be seen on display.

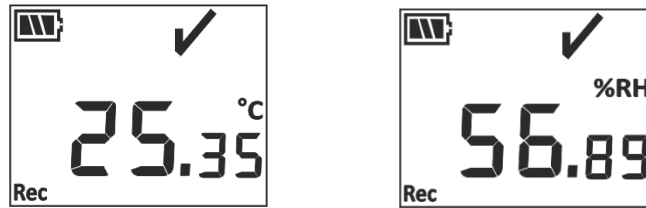

- 2) Reading is outside the **cumulative alarm** high/low set point for time duration **less than** the **cumulative alarm** high/low delay.
 - OK sign, battery, reading with UP/ Down arrow, cumulative event indication arrow and unit will be seen on display.

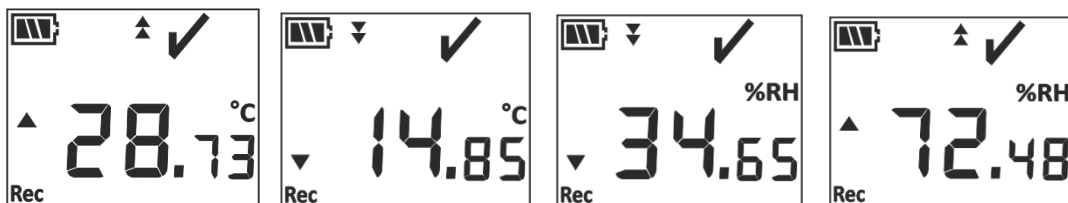

- 3) Reading is outside the **cumulative alarm** high/low set point for time duration **greater than** the cumulative alarm high/low delay.
 - Alarm sign, bell sign, battery, reading with Up/ Down arrow, Cumulative event indication and unit will be seen on display.

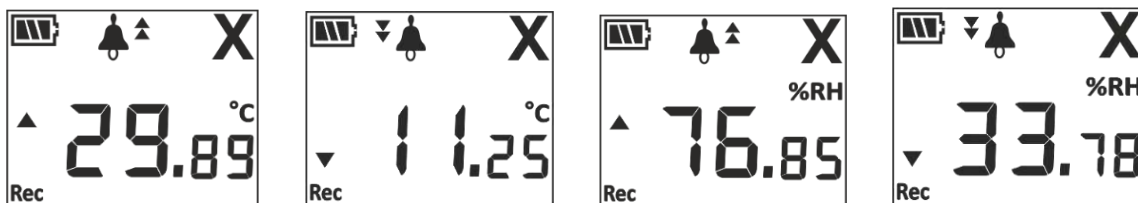

- 4) Reading is outside of **both the single and cumulative** set point high/low for time less than alarm high/low delay for both single and cumulative event.
 - OK sign, battery, bell symbol, reading with Up/ Down arrow, cumulative event indication and unit will be seen on display.

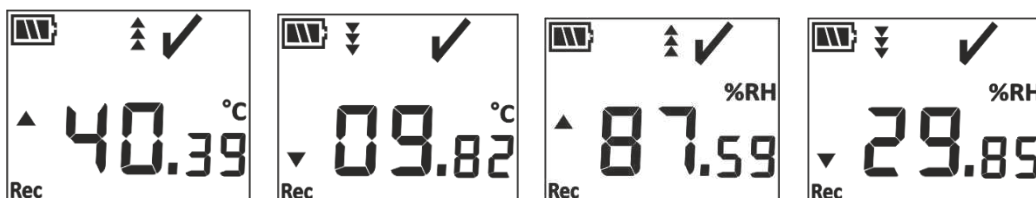

- 5) Reading is outside of **both the single and cumulative** set point high/low for time greater than alarm high/low delay for both single and cumulative event.
 - Alarm sign, battery, bell symbol, reading with Up/ Down arrow, single and cumulative event indication and unit will be seen on display.

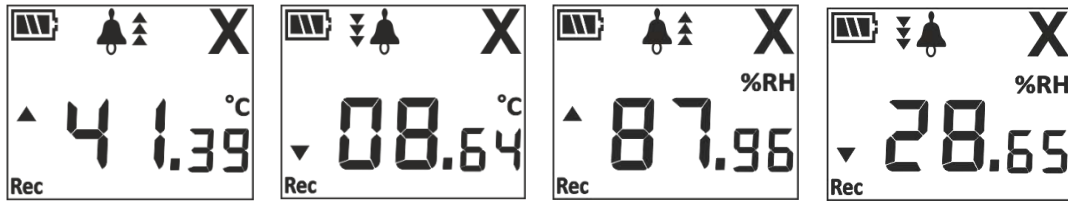

5.7 Measurement of the data

5.7.1 Start Recording data

- The Data recording can be started by one the criteria explained in [section 5.3](#).
- The device will store the data as per configured store interval, which can be downloaded later on for analysis.

5.7.2 Tag Events

- When alarm high/low condition arises for Temperature and/ Humidity, alarm triggered tag event is logged.
- Alarm restored tag event is logged when Temperature/Humidity reading comes within the alarm high/low limits.
- User entered Tag is logged as Manual Tag Event with a time stamp.

Tag ID	Tag Event	Description
Temperature Tags		
A1	Alarm1 Triggered	Alarm1 high/low condition has occurred.
B1	Alarm1 Reset	Alarm1 high/low condition is restored.
A2	Alarm2 Triggered	Alarm2 high/low condition has occurred.
B2	Alarm2 Reset	Alarm2 high/low condition is restored.
A3	Alarm3 Triggered	Alarm3 high/low condition has occurred.
B3	Alarm3 Reset	Alarm3 high/low condition is restored.
A4	Alarm4 Triggered	Alarm4 high/low condition has occurred.
B4	Alarm4 Reset	Alarm4 high/low condition is restored.
Humidity Tags		
A5	Alarm5 Triggered	Alarm5 high/low condition has occurred.
B5	Alarm5 Reset	Alarm5 high/low condition is restored.
A6	Alarm6 Triggered	Alarm6 high/low condition has occurred.
B6	Alarm6 Reset	Alarm6 high/low condition is restored.
A7	Alarm7 Triggered	Alarm7 high/low condition has occurred.
B7	Alarm7 Reset	Alarm7 high/low condition is restored.
A8	Alarm8 Triggered	Alarm8 high/low condition has occurred.
B8	Alarm8 Reset	Alarm8 high/low condition is restored.
Manual Tag:		
Tag	Manual Tag	User has entered a tag from device.

Note: Number of data records get reduced according to number of Tag data events. Tag Event(s) can be seen in software application and generated pdf report after downloading data.

5.7.3 Ending the Measurement

1. When the Batch type selected as Stop on Full:

- The batch can be stopped by Four ways:
 - 1) As per the preconfigured batch stop time, the measurement will be stopped.
 - 2) If batch stop time is not set during the batch configuration, the measurement will be stopped, once the maximum no. of readings has reached.
 - 3) By connecting the device with the LMViewE051 application, using “**Stop**” option.
 - 4) User can manually Stop the running batch if required, by pressing “**Min/Max**” key for about 10 seconds as shown in figure 11. Here a Manual Tag event will be logged prior to batch stop message



Figure 11 Manual Stop of Running Batch

2. When the Batch type selected as Rollover:

- The measurement program continues even after the maximum no. readings is reached, by overwriting the data cyclically on a first-in-first-out basis.
- The measurement program is ended by one of the two ways:
 - 1) By connecting the device with the LMViewE051 application, using “**Stop**” option.
 - 2) User can manually Stop the running batch if required, by pressing “**Min/Max**” key for about 10 seconds as shown in figure 10. Here a Manual Tag event will be logged prior to batch stop message.
- Once the measurement stops, “**REC**” message disappears from the device display and **RUN** LED turns Off and **STP** LED starts flashing.

5.8 Reading out Data

5.8.1 Connecting with the Software Application

Displaying a measurement data report

- Connect the LM^{Pro} H data logger with Windows PC via the USB port, as shown in figure 12.

- After connecting the data logger with PC, the display remains ON along with the other values.

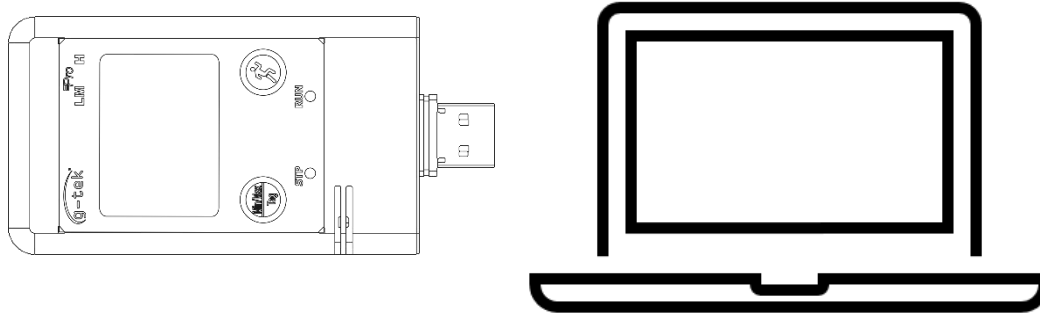



Figure 12 USB Type- A connection

5.8.2 Download the Measurement Readings

- Open LMViewE051 software Application to carry out analysis for the measurement readings.
- Click on USB  icon to connect the device with the LMViewE051. The current Temperature and Humidity reading, Battery level and UTC time of the device will be seen as shown in figure 13.

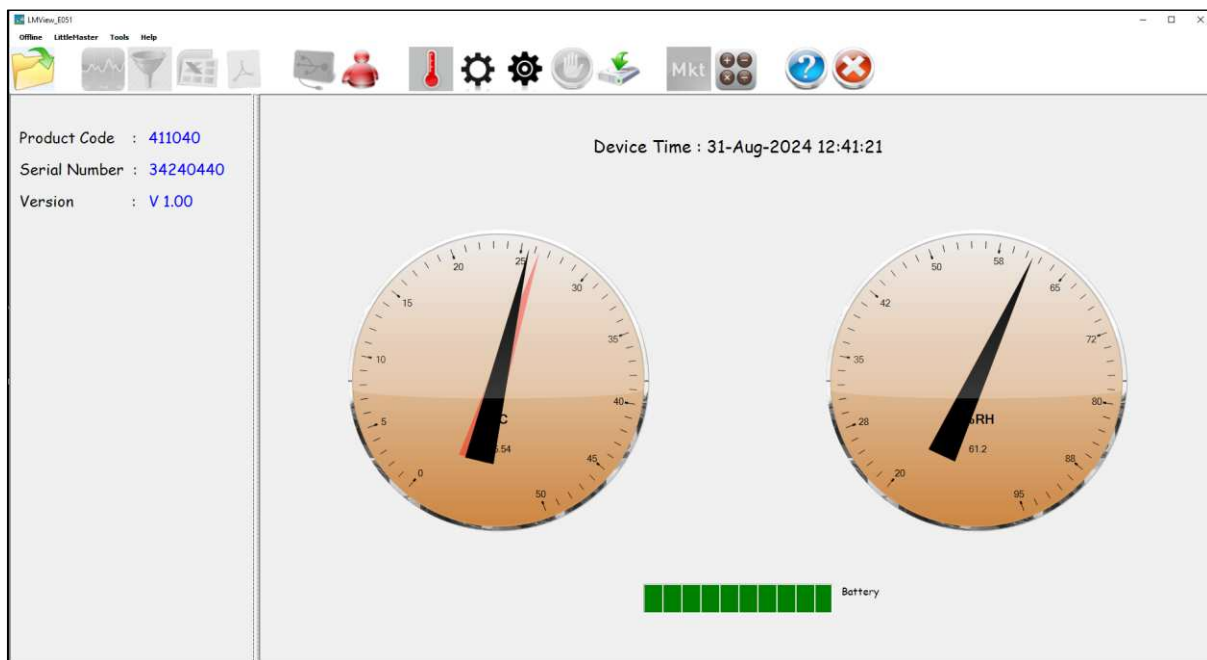

Figure 13 Current Temperature & Humidity reading of the LM^{Pro} H Data Logger

- Select the download option, choose the appropriate file path and batch file name for saving the data file and press button in the pop-up window as shown in figure 14.

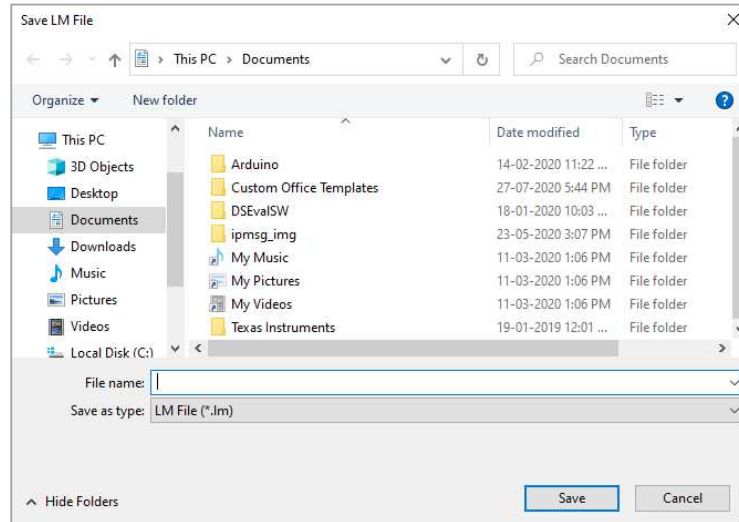

Figure 14 Selecting file location for saving data summary

- Downloading of data will be completed after some time and downloaded data can be seen in tabular form as shown in figure 15.

Sr.No	Date And Time	Temperature (°C)	Humidity (%RH)
1	15-03-2023 15:54:10	26.56	44.08
2	15-03-2023 15:54:15	26.63	46.11
3	15-03-2023 15:54:20	26.66	45.79
4	15-03-2023 15:54:25	26.69	46.34
5	15-03-2023 15:54:30	26.71	46.15
6	15-03-2023 15:54:35	26.72	45.75
7	15-03-2023 15:54:40	26.73	45.23
8	15-03-2023 15:54:45	26.74	44.07
9	15-03-2023 15:54:50	26.75	43.66
10	15-03-2023 15:54:55	26.76	43.38
11	15-03-2023 15:55:00	26.76	44.22
Tag	15-03-2023 15:55:04	26.77	45.01
12	15-03-2023 15:55:05	26.78	45.52
13	15-03-2023 15:55:10	26.78	46.38
14	15-03-2023 15:55:15	26.79	47.73
15	15-03-2023 15:55:20	26.80	48.55
16	15-03-2023 15:55:25	26.82	48.56
17	15-03-2023 15:55:30	26.83	50.22
18	15-03-2023 15:55:35	26.86	49.35
19	15-03-2023 15:55:40	26.87	47.68
20	15-03-2023 15:55:45	26.87	45.33
21	15-03-2023 15:55:50	26.87	42.79
22	15-03-2023 15:55:55	26.86	40.90
23	15-03-2023 15:56:00	26.85	39.96
24	15-03-2023 15:56:05	26.84	39.86
25	15-03-2023 15:56:10	26.82	40.13
26	15-03-2023 15:56:15	26.82	40.14
27	15-03-2023 15:56:20	26.82	40.11
28	15-03-2023 15:56:25	26.81	39.79
29	15-03-2023 15:56:30	26.79	39.38
30	15-03-2023 15:56:35	26.78	39.42
31	15-03-2023 15:56:40	26.76	39.52
Minimum	15-03-2023 16:51:20	15-03-2023 16:15:35	
	--	25.57	37.39
Maximum	15-03-2023 16:14:40	15-03-2023 16:30:20	
	--	27.29	53.99

Figure 15 Downloaded data summary

- The data analysis can be done by
 1. Min, Max, Average and MKT for the downloaded data
 2. Filtering the time period for which measurement data review is required,
 3. View the graph to observe the trend of measured data.
 4. Generate csv file of the measured readings
 5. Generate PDF report
- User can download multiple device data in the same file, if the configuration is same for the given devices.

- Download the first device data and connect the second device to download the data, select option “Yes” in the message pop up as shown in figure 16 for downloading in existing file.
- Repeat the same process for remaining devices.

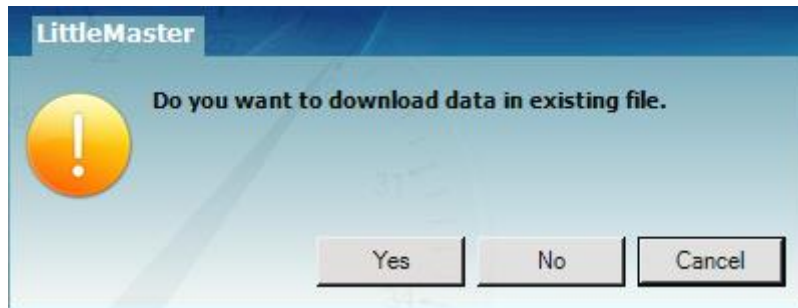

Figure 16 Option for downloading multiple device data in existing file

- Multiple device data are stored in one file as shown in figure 17.

Sr.No	Date And Time	10230003 Temperature (C)	10230003 Humidity (%RH)	10230002 Temperature (C)	10230002 Humidity (%RH)	10230010 Temperature (C)	10230010 Humidity (%RH)	10230022 Temperature (C)	10230022 Humidity (%RH)	10230004 Temperature (C)	10230004 Humidity (%RH)	10230018 Temperature (C)
1	15-03-2023 18:35:00	27.01	40.11	26.33	41.29	25.89	42.70	25.87	42.41	26.14	42.29	26.07
2	15-03-2023 18:35:10	26.75	40.51	26.24	41.41	25.85	42.71	25.86	42.54	26.19	42.30	26.02
3	15-03-2023 18:35:20	26.46	40.80	26.14	41.58	25.79	42.85	25.84	42.67	26.15	42.36	25.98
4	15-03-2023 18:35:30	26.18	41.32	26.04	41.72	25.73	42.49	25.82	42.80	26.09	42.48	25.88
5	15-03-2023 18:35:40	25.89	40.82	25.93	41.39	25.65	41.85	25.79	42.20	26.03	41.77	25.79
6	15-03-2023 18:35:50	25.88	40.83	25.92	41.39	25.64	41.84	25.79	42.21	26.03	41.77	25.78
7	15-03-2023 18:36:00	25.87	40.85	25.91	41.40	25.63	41.84	25.78	42.21	26.02	41.76	25.76
8	15-03-2023 18:36:10	25.86	40.86	25.90	41.40	25.62	41.85	25.77	42.21	26.02	41.76	25.75
9	15-03-2023 18:36:20	25.85	40.88	25.89	41.40	25.61	41.86	25.77	42.20	26.02	41.75	25.73
10	15-03-2023 18:36:30	25.83	40.89	25.88	41.40	25.60	41.88	25.76	42.21	26.01	41.75	25.72
11	15-03-2023 18:36:40	25.82	40.90	25.88	41.39	25.59	41.90	25.76	42.21	26.00	41.74	25.71
12	15-03-2023 18:36:50	25.80	40.89	25.86	41.38	25.58	41.92	25.76	42.20	26.00	41.74	25.69
13	15-03-2023 18:37:00	25.78	40.90	25.85	41.39	25.58	41.92	25.75	42.20	26.00	41.73	25.68
14	15-03-2023 18:37:10	25.77	40.90	25.85	41.39	25.58	41.92	25.75	42.20	25.99	41.73	25.66
15	15-03-2023 18:37:20	25.75	40.90	25.84	41.39	25.57	41.90	25.75	42.20	25.99	41.72	25.65
16	15-03-2023 18:37:30	25.73	40.92	25.84	41.40	25.56	41.88	25.74	42.20	25.99	41.72	25.64
17	15-03-2023 18:37:40	25.72	40.94	25.83	41.40	25.55	41.88	25.74	42.21	25.99	41.71	25.63
18	15-03-2023 18:37:50	25.70	40.96	25.82	41.41	25.53	41.88	25.73	42.21	25.98	41.71	25.61
19	15-03-2023 18:38:00	25.69	40.97	25.82	41.41	25.52	41.88	25.72	42.21	25.98	41.71	25.60
20	15-03-2023 18:38:10	25.68	40.98	25.82	41.40	25.51	41.88	25.72	42.21	25.97	41.71	25.58
21	15-03-2023 18:38:20	25.68	40.98	25.81	41.39	25.50	41.86	25.71	42.21	25.97	41.70	25.57
22	15-03-2023 18:38:30	25.67	40.98	25.81	41.39	25.50	41.85	25.71	42.21	25.96	41.70	25.56
23	15-03-2023 18:38:40	25.67	40.97	25.81	41.38	25.50	41.84	25.71	42.21	25.96	41.70	25.55
24	15-03-2023 18:38:50	25.66	40.98	25.80	41.39	25.49	41.84	25.71	42.21	25.96	41.69	25.55
25	15-03-2023 18:39:00	25.65	40.99	25.79	41.39	25.48	41.85	25.69	42.21	25.96	41.69	25.54
26	15-03-2023 18:39:10	25.63	40.99	25.78	41.37	25.47	41.86	25.69	42.21	25.96	41.69	25.55
27	15-03-2023 18:39:20	25.63	40.99	25.77	41.36	25.46	41.86	25.67	42.21	25.96	41.69	25.54
28	15-03-2023 18:39:30	25.61	40.99	25.77	41.35	25.46	41.86	25.67	42.20	25.96	41.69	25.54
29	15-03-2023 18:39:40	25.61	40.98	25.76	41.34	25.45	41.85	25.65	42.20	25.95	41.69	25.53
30	15-03-2023 18:39:50	25.60	40.99	25.76	41.34	25.45	41.85	25.65	42.20	25.95	41.68	25.53
31	15-03-2023 18:40:00	25.60	40.99	25.75	41.34	25.45	41.85	25.64	42.20	25.95	41.67	25.52
32	15-03-2023 18:40:10	25.59	41.00	25.75	41.34	25.44	41.84	25.64	42.20	25.94	41.66	25.50
Minimum	--	15-03-2023 11:51:00	15-03-2023 09:36:20	15-03-2023 11:50:50	15-03-2023 09:59:50	15-03-2023 11:51:50	15-03-2023 09:27:00	15-03-2023 18:27:00	15-03-2023 09:33:50	15-03-2023 11:51:00	15-03-2023 09:58:00	15-03-2023 11:50:30
		24.54	40.04	24.69	40.90	24.65	41.02	24.09	40.40	24.52	41.50	24.49
Maximum	--	15-03-2023 09:08:20	15-03-2023 09:07:00	15-03-2023 09:08:00	15-03-2023 09:06:50	15-03-2023 09:06:40	15-03-2023 09:06:00	15-03-2023 09:07:10	15-03-2023 09:06:00	15-03-2023 09:09:00	15-03-2023 09:07:00	15-03-2023 09:07:00
		28.15	48.96	28.13	49.90	28.24	51.75	28.10	49.00	28.05	47.86	28.14

Figure 17 Multiple device data in One file

Note: The user should download multiple devices up to 10 in one file to sustain readability of the data in the graph and PDF report.

5.8.3 Generating PDF Report

- To generate the PDF report of data, click on  icon. A pop up window will appear with the following options as shown in figure 18.

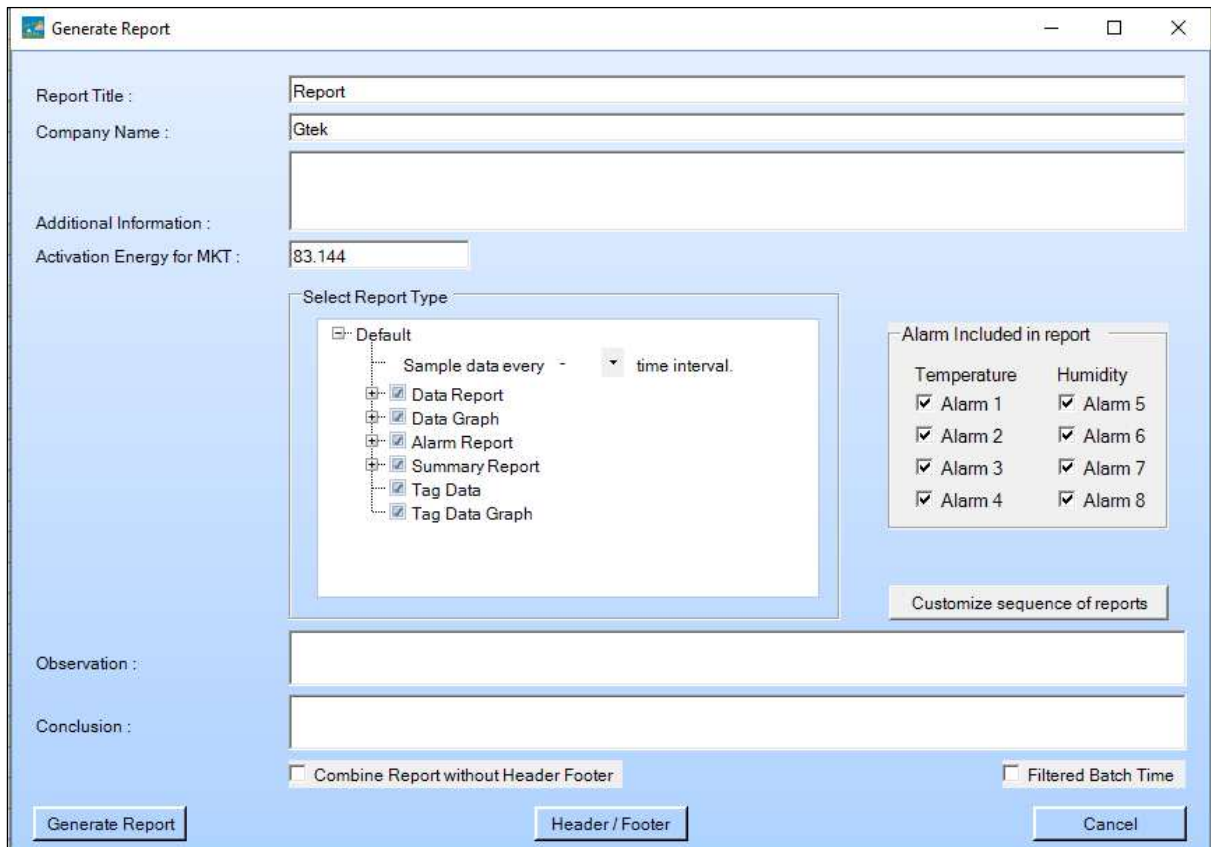

Figure 18 Filling up the options to generate PDF report

- Enter the proper information in the fields given for generating the PDF report.
- Finally select the “**Generate Report**” button to save the generated PDF report at appropriate file location as shown in figure 19.

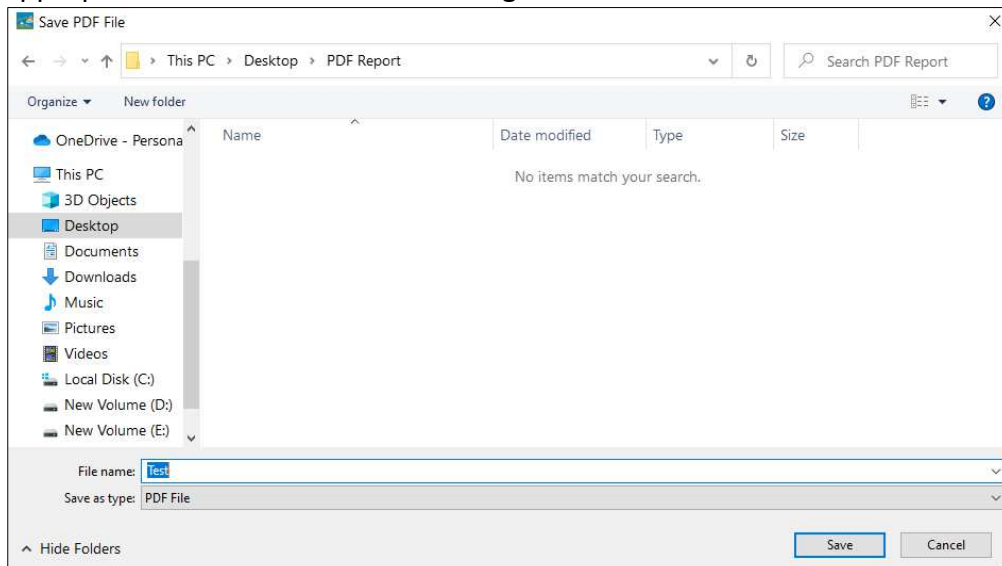

Figure 19 Selecting file location for saving PDF report

Note: Refer to the help menu of LMViewE051 software application for detailed description of the PDF report terms.

6 MAINTAINING THE PRODUCT

6.1 Accessories

- Battery (3V, 225 mAh; CR2032 coin cell)
- Device calibration certificate

6.2 Cleaning the Data Logger

Ensure that no liquid enters inside the housing.

- If the housing of Data logger gets dirty, clean it with damp cloth.
- Do not use any aggressive cleaning agents or solvents.
- When a USB port is not in use, cover the USB port properly.

6.3 Changing the Battery

- The LM^{Pro} H data logger contains a Lithium Battery. The end of the battery life is indicated by a low battery symbol; the battery should be replaced within 15 days when this symbol appears.
- **Download the batch data before changing the battery of the device.**
- Battery Installation/change steps are shown in figure 20 as follows:

1. Place the data logger on its back side.

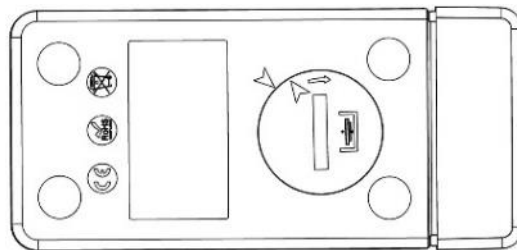

2. Open the battery cover with a coin turning in anti-clockwise direction.

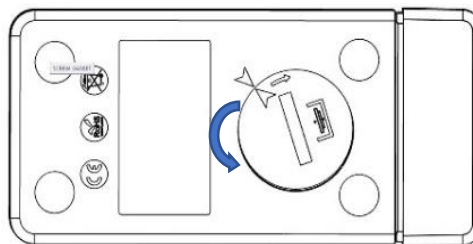

3. Insert the battery (3 V coin cell, CR2032) in a way that the positive terminal of battery is visible.

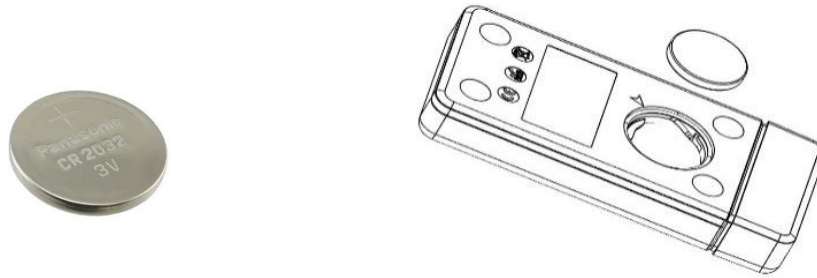

4. Place the cover back on the battery compartment in arrow matching position and close it by turning in clockwise direction till both the arrows do not match as shown in below image:

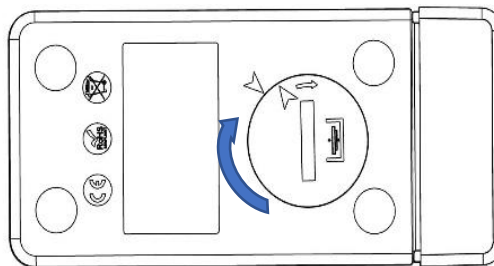

Figure 20 Battery replacement steps

- The data logger's display turns ON and Both Status LEDs blink one time.
- Battery replacement stops a measurement that is currently running. However, stored measurement data are preserved.
- When a new battery is inserted, the min/max value for the current data will be calculated from that time onwards and batch recording is resumed.
- It is advisable to reconfigure the data logger after changing the battery.

Note: It is advisable to reconfigure the data logger after changing the battery.



6.4 Battery Disposal

- Dispose or recycle the battery in accordance with your local regulations.
- Do not expose the Data Logger to extreme temperatures as it may lead to the destruction of the battery and may cause injuries.

“Warning, Battery may explode if mistreated. Do not recharge, disassemble, or dispose of in fire.”

7 TIPS AND ASSISTANCE

Table 3 Frequent Asked Questions (FAQs)

Questions	Possible Cause/ Solution
How to view/set current UTC time?	<ul style="list-style-type: none"> Connect the device with LMViewE051 application, the software window will show current reading along with UTC time. User can set/update the UTC time by configuring the batch and syncing the current time with PC clock.
Device is not connected in software application.	<ul style="list-style-type: none"> See that during insert of device in USB port of PC, both status LEDs blink 1 time together. Try to reconnect in USB and LMViewE051 software. USB port might be faulty, try with other port of PC. In case of USB Type C port, use USB Type C to Type A female cable for connecting the device.
For how much time, the display remains ON after device activation?	<ul style="list-style-type: none"> Display turns off after 1 minute of activity if LCD is configured as Auto OFF in batch configuration. The display is normally off to save the battery life when no activity on device.
How display indicates for both single and cumulative alarms triggered?	<ul style="list-style-type: none"> In case of both single and cumulative alarm High  and Low  triggered, all 3 arrows will be displayed for high /low alarm condition.
If user does not want to configure all alarms?	<ul style="list-style-type: none"> User will have to configure all the alarms , the alarms not required by user can be set to Highest and lowest settable set point.